



Αγκύβεις χωρίς λόγια  
11-8-2014  
Μιχάλης Νάννος

60 ΕΥΚΟΛΕΣ ΟΙΚΕΙΕΣ ΠΟΛΥΠΛΗΘΥΣ ΕΠΙΛΟΧΗΣ ΠΑΝΩ ΣΤΗΝ ΕΥΡΕΣΗ ΓΩΝΙΩΝ.

Κατάλληλες για μαθητές της Α Λυκείου ή και για μαθητές Γυμνασίου.

Στην τελευταία σελίδα θα βρείτε τις σωστές απαντήσεις.

1

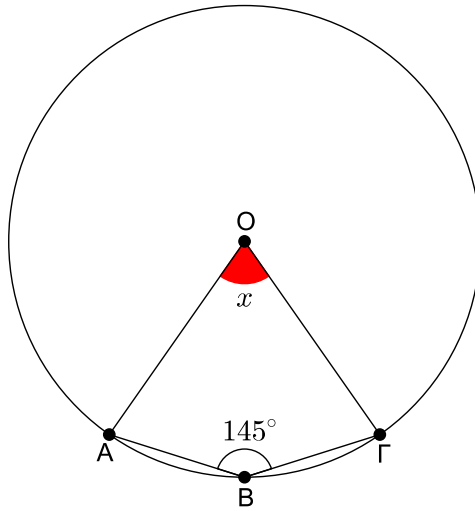

- A)  $50^\circ$  B)  $60^\circ$  Γ)  $70^\circ$  Δ)  $80^\circ$  E)  $90^\circ$

2

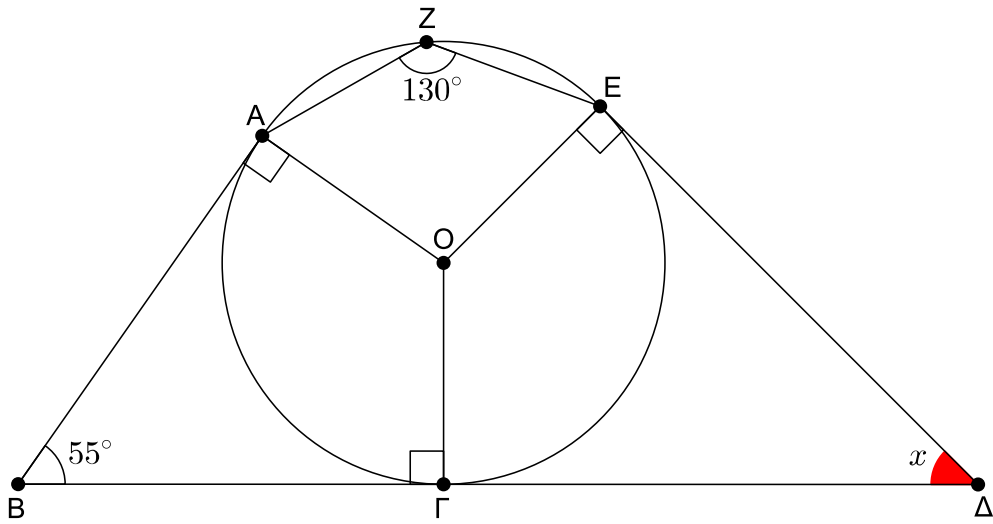

- A)  $30^\circ$  B)  $35^\circ$  Γ)  $40^\circ$  Δ)  $45^\circ$  E)  $50^\circ$

3

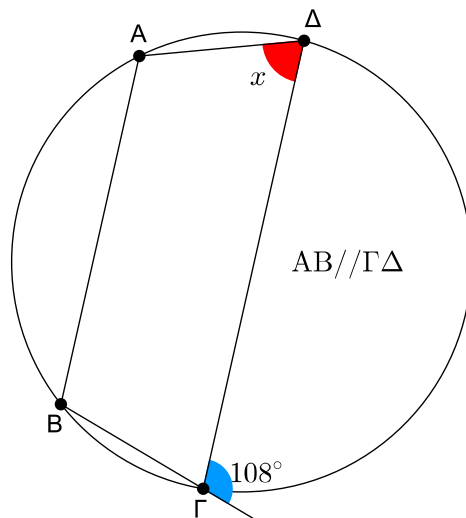

- A)  $60^\circ$  B)  $70^\circ$  Γ)  $72^\circ$  Δ)  $108^\circ$  E)  $120^\circ$

4

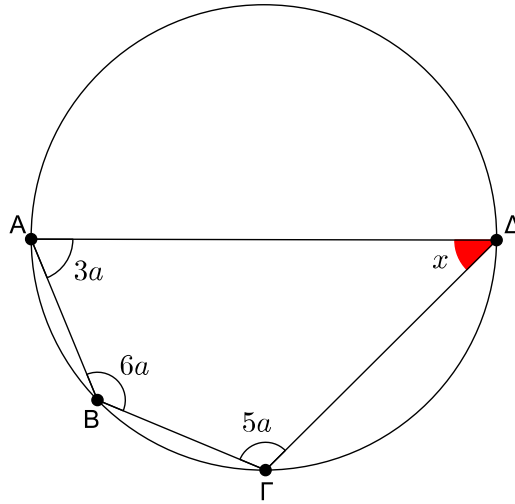

- A)  $24^\circ$  B)  $30^\circ$  Γ)  $36^\circ$  Δ)  $42^\circ$  E)  $45^\circ$

5

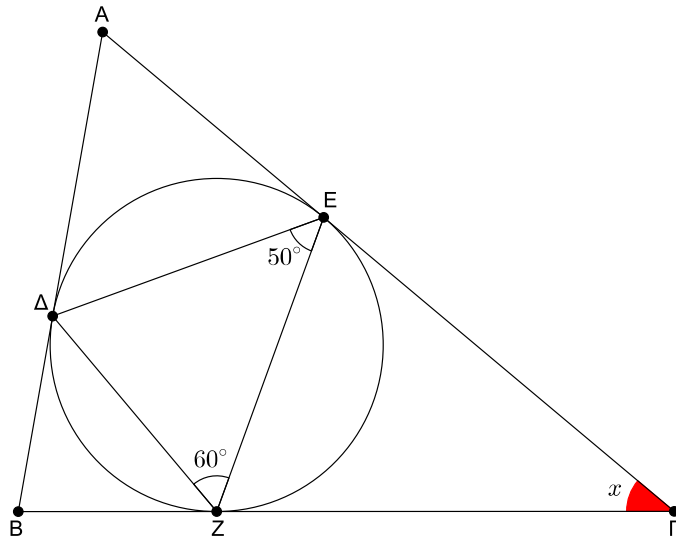

- A)  $20^\circ$  B)  $30^\circ$  Γ)  $40^\circ$  Δ)  $45^\circ$  E)  $50^\circ$

6

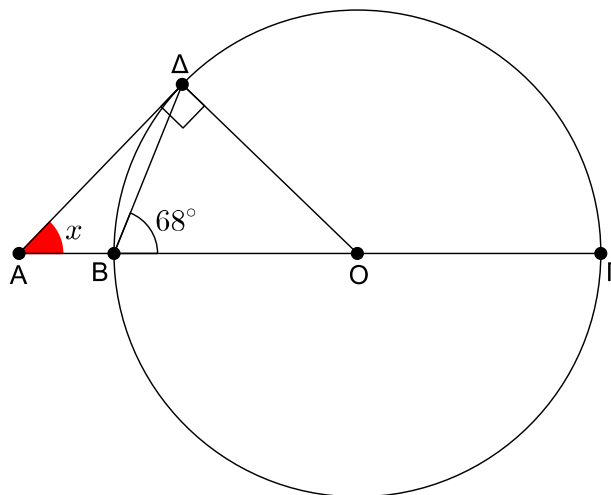

- A)  $48^\circ$  B)  $46^\circ$  Γ)  $44^\circ$  Δ)  $36^\circ$  E)  $32^\circ$

7

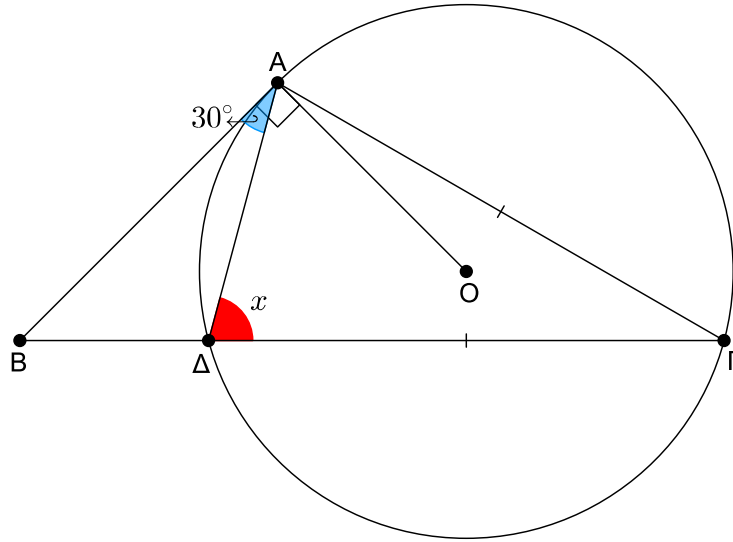

- A)  $60^\circ$  B)  $70^\circ$  Γ)  $75^\circ$  Δ)  $80^\circ$  E)  $85^\circ$

8

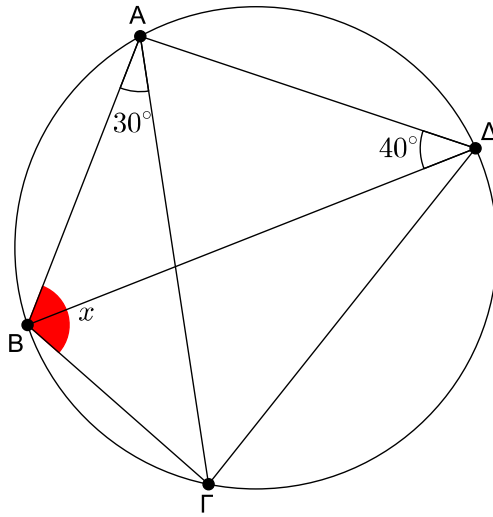

- A)  $90^\circ$  B)  $100^\circ$  Γ)  $110^\circ$  Δ)  $120^\circ$  E)  $130^\circ$

9

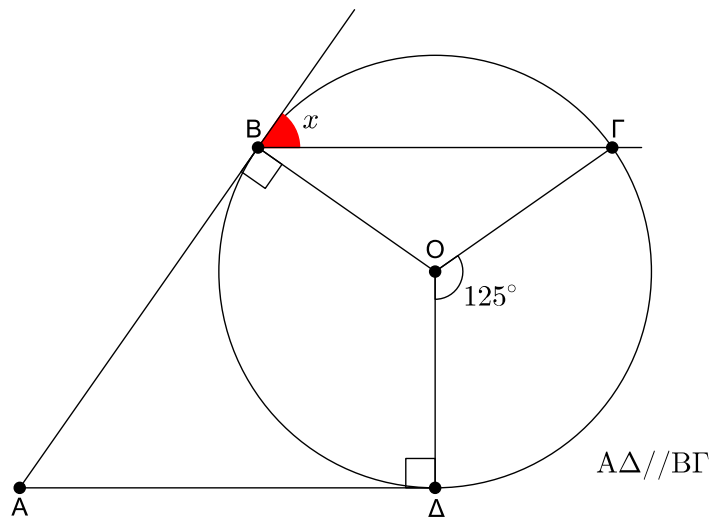

- A)  $40^\circ$  B)  $45^\circ$  Γ)  $50^\circ$  Δ)  $55^\circ$  E)  $60^\circ$

10

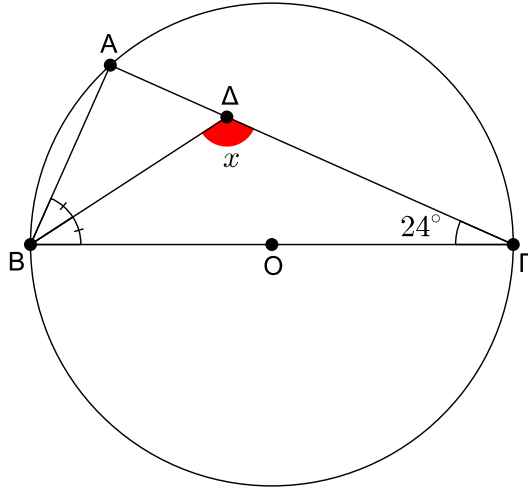

- A)  $123^\circ$  B)  $126^\circ$  Γ)  $127^\circ$  Δ)  $130^\circ$  E)  $133^\circ$

11

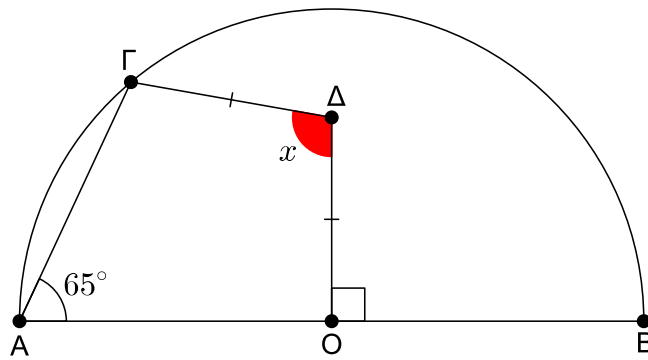

- A)  $80^\circ$  B)  $85^\circ$  Γ)  $90^\circ$  Δ)  $95^\circ$  E)  $100^\circ$

12

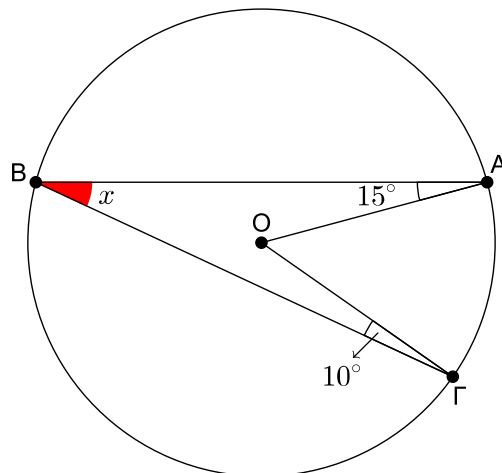

- A)  $15^\circ$  B)  $20^\circ$  Γ)  $25^\circ$  Δ)  $30^\circ$  E)  $35^\circ$

13

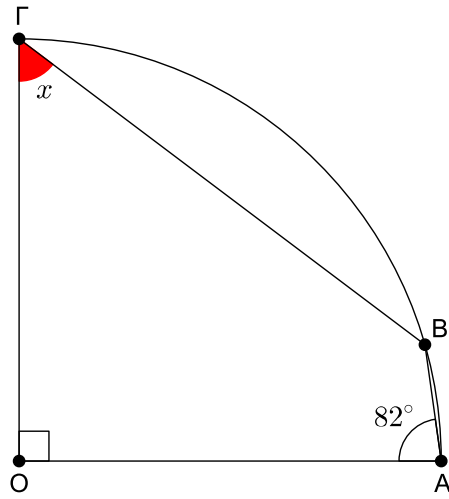

- A)  $84^\circ$  B)  $74^\circ$  Γ)  $63^\circ$  Δ)  $53^\circ$  E)  $43^\circ$

14

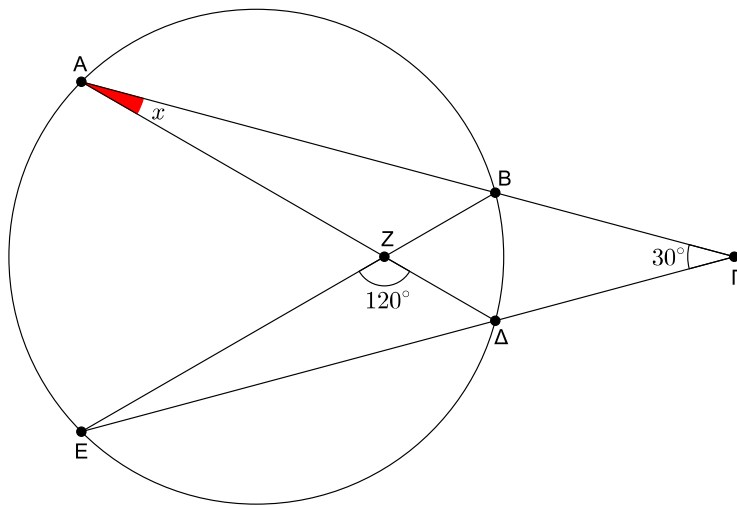

- A)  $30^\circ$  B)  $25^\circ$  Γ)  $20^\circ$  Δ)  $15^\circ$  E)  $10^\circ$

15

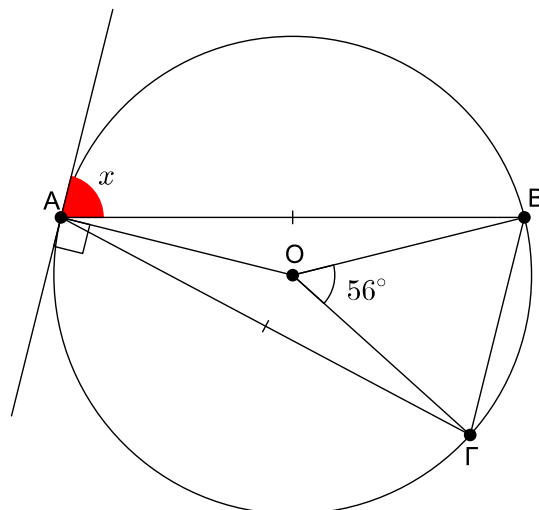

- A)  $38^\circ$  B)  $56^\circ$  Γ)  $64^\circ$  Δ)  $72^\circ$  E)  $76^\circ$

16

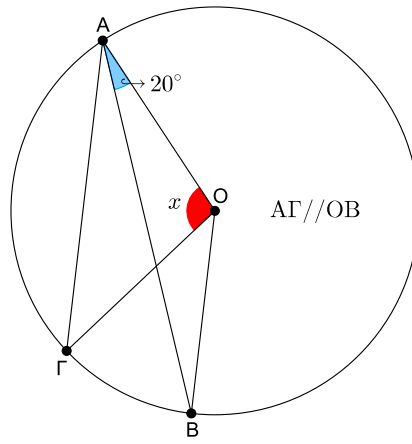

- A)  $80^\circ$  B)  $90^\circ$  Γ)  $100^\circ$  Δ)  $110^\circ$  E)  $120^\circ$

17

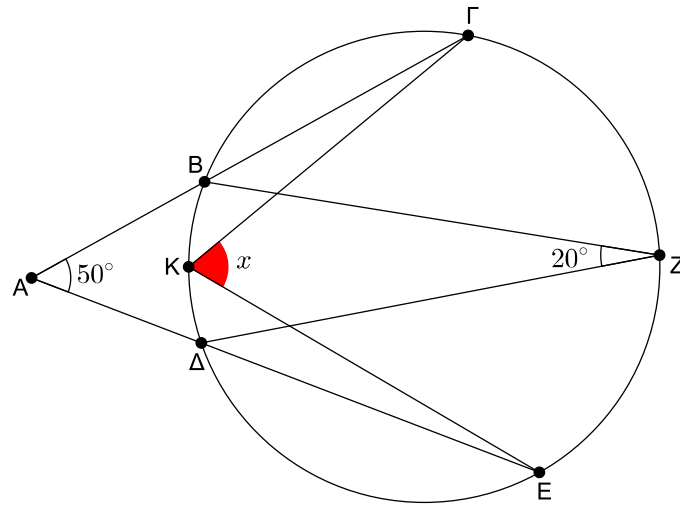

- A)  $60^\circ$  B)  $70^\circ$  Γ)  $80^\circ$  Δ)  $85^\circ$  E)  $90^\circ$

18

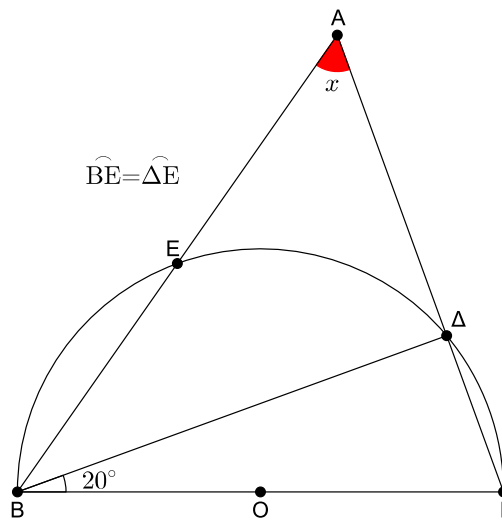

- A)  $40^\circ$  B)  $45^\circ$  Γ)  $50^\circ$  Δ)  $55^\circ$  E)  $60^\circ$



19

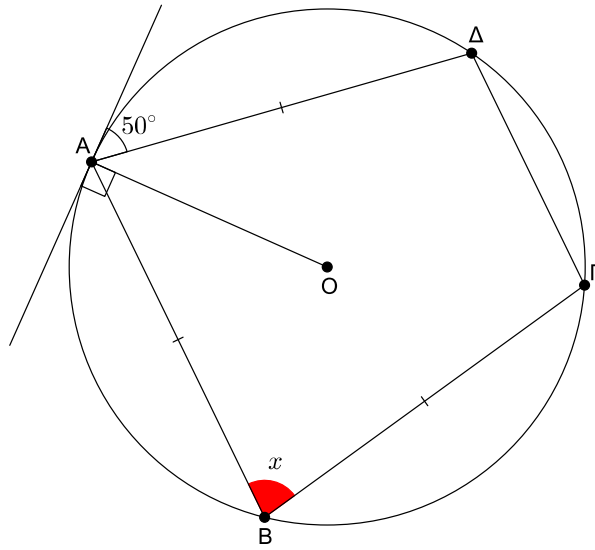

- A)  $60^\circ$  B)  $70^\circ$  Γ)  $75^\circ$  Δ)  $80^\circ$  E)  $90^\circ$

20

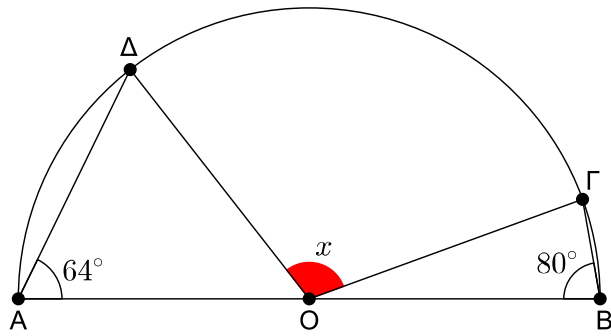

- A)  $102^\circ$  B)  $106^\circ$  Γ)  $108^\circ$  Δ)  $110^\circ$  E)  $112^\circ$

21

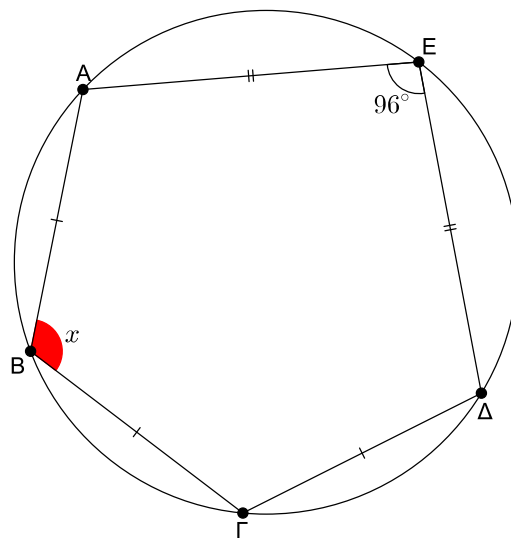

- A)  $116^\circ$  B)  $120^\circ$  Γ)  $122^\circ$  Δ)  $123^\circ$  E)  $124^\circ$

22

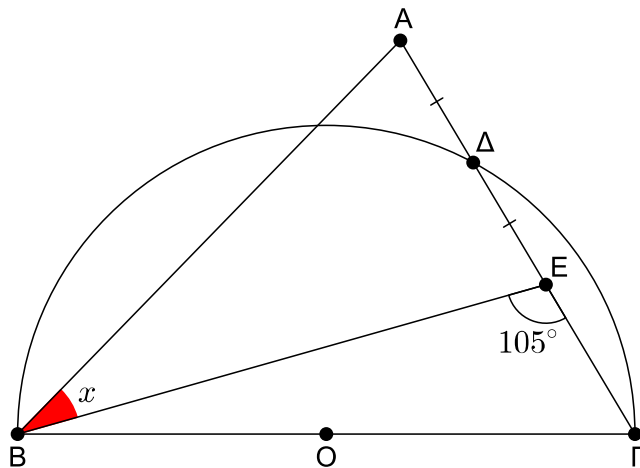

- A)  $15^\circ$  B)  $20^\circ$  Γ)  $30^\circ$  Δ)  $35^\circ$  E)  $40^\circ$

23

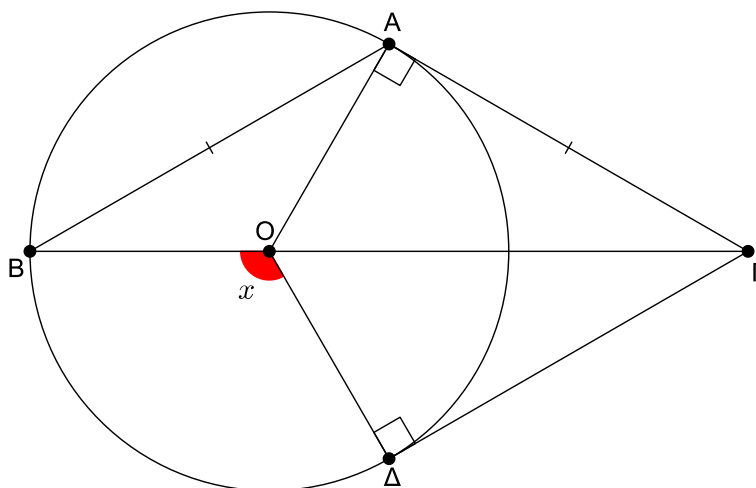

- A)  $120^\circ$  B)  $115^\circ$  Γ)  $110^\circ$  Δ)  $100^\circ$  E)  $95^\circ$

24

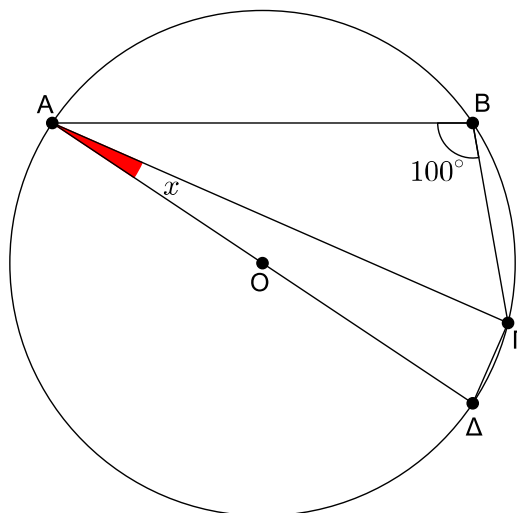

- A)  $10^\circ$  B)  $20^\circ$  Γ)  $30^\circ$  Δ)  $40^\circ$  E)  $50^\circ$

25

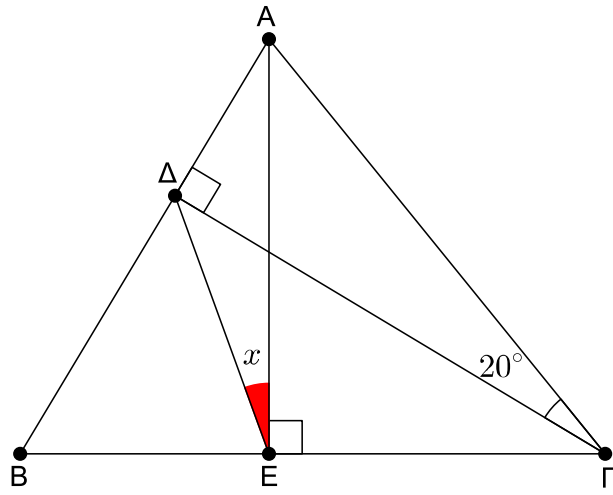

- A)  $10^\circ$  B)  $20^\circ$  Γ)  $30^\circ$  Δ)  $40^\circ$  E)  $50^\circ$

26

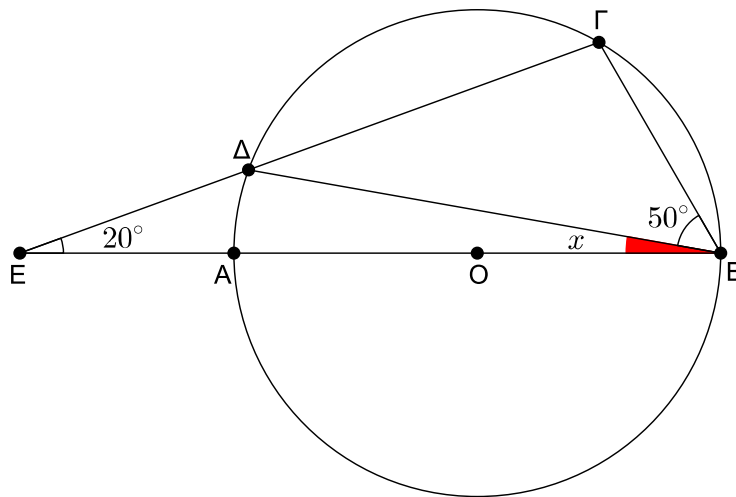

- A)  $30^\circ$  B)  $25^\circ$  Γ)  $20^\circ$  Δ)  $15^\circ$  E)  $10^\circ$

27

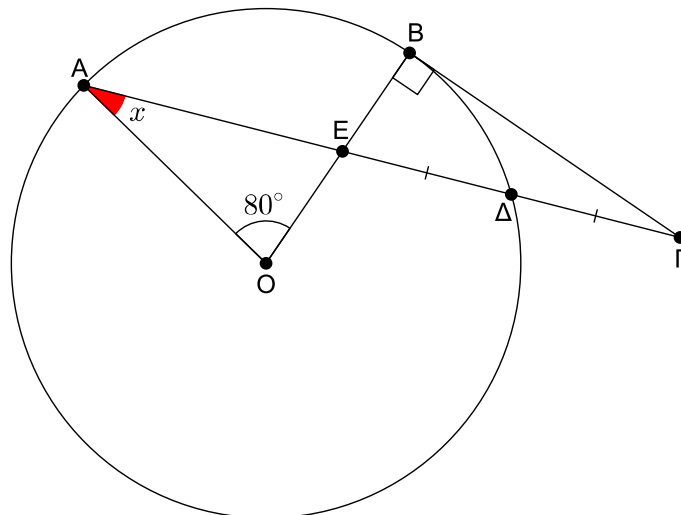

- A)  $60^\circ$  B)  $45^\circ$  Γ)  $40^\circ$  Δ)  $30^\circ$  E)  $15^\circ$

28

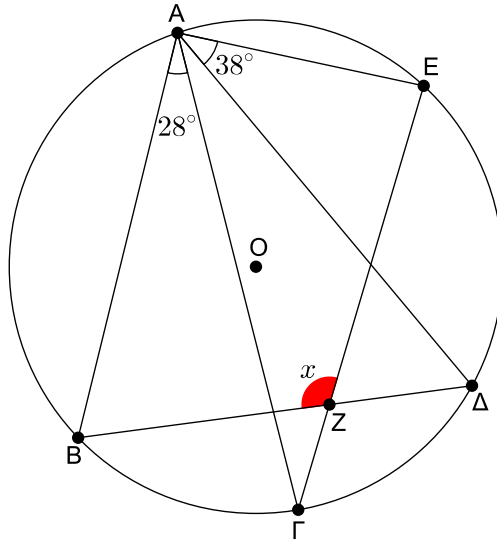

- A)  $114^\circ$  B)  $112^\circ$  Γ)  $110^\circ$  Δ)  $108^\circ$  E)  $106^\circ$

29

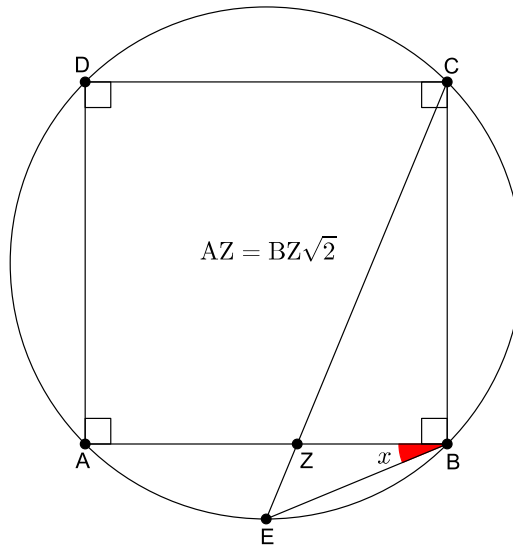

- A)  $15^\circ$  B)  $20^\circ$  Γ)  $22,5^\circ$  Δ)  $27,5^\circ$  E)  $30^\circ$

30

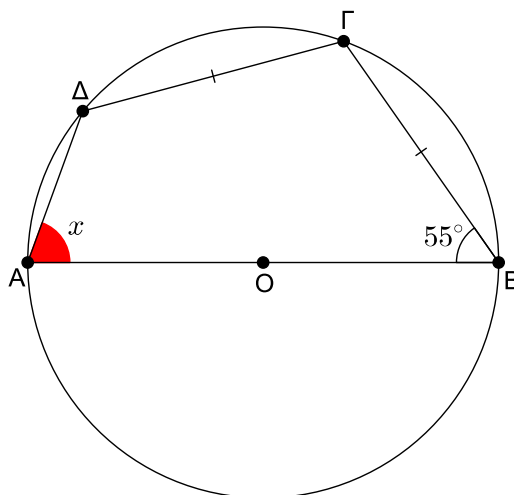

- A)  $80^\circ$  B)  $70^\circ$  Γ)  $60^\circ$  Δ)  $50^\circ$  E)  $40^\circ$

31

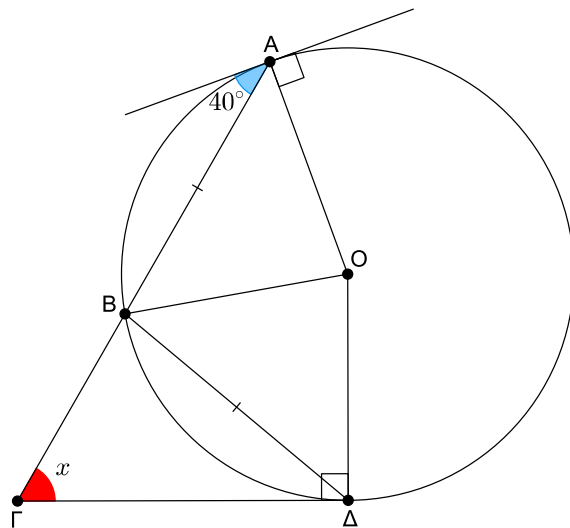

A)  $50^\circ$  B)  $60^\circ$  Γ)  $70^\circ$  Δ)  $80^\circ$  E)  $90^\circ$

32

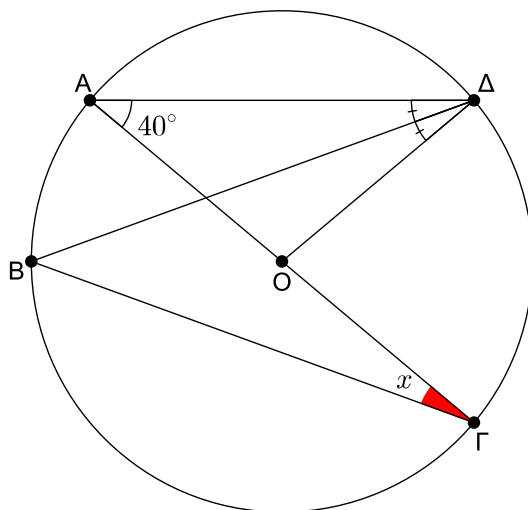

A)  $35^\circ$  B)  $30^\circ$  Γ)  $25^\circ$  Δ)  $20^\circ$  E)  $15^\circ$

33

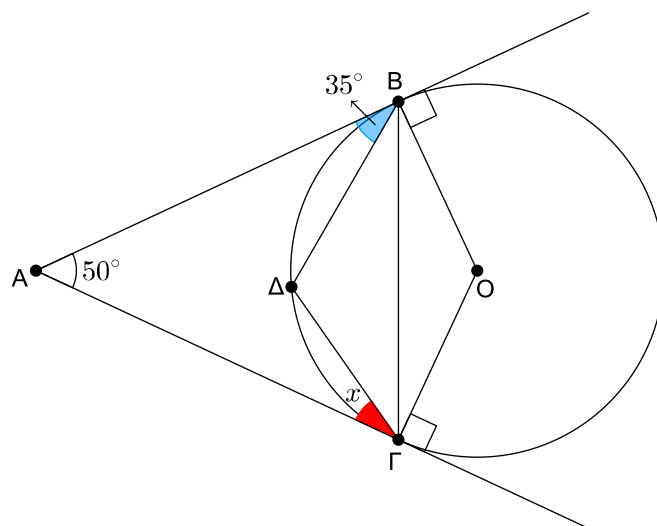

A)  $20^\circ$  B)  $25^\circ$  Γ)  $30^\circ$  Δ)  $35^\circ$  E)  $40^\circ$

34

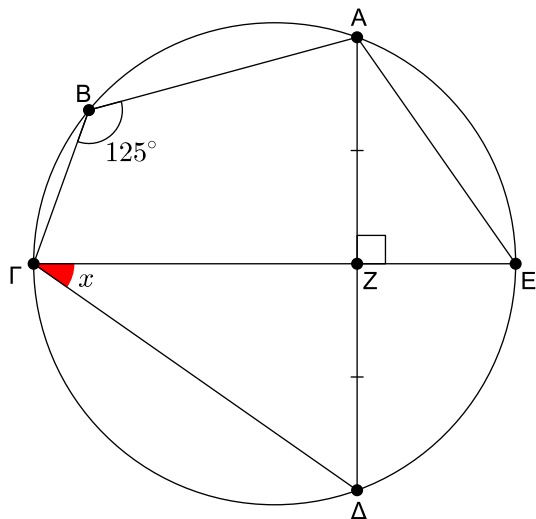

- A)  $55^\circ$  B)  $50^\circ$  Γ)  $45^\circ$  Δ)  $40^\circ$  E)  $35^\circ$

35

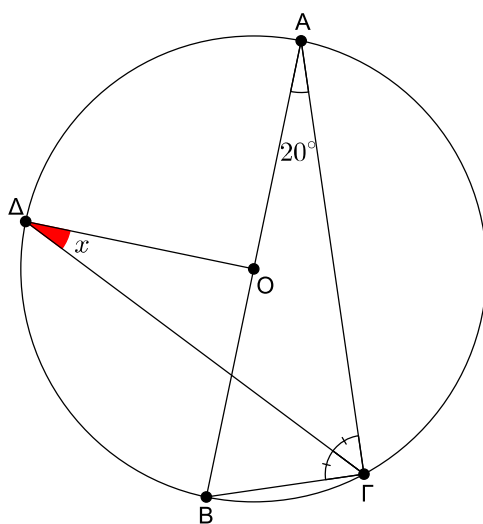

- A)  $10^\circ$  B)  $15^\circ$  Γ)  $20^\circ$  Δ)  $25^\circ$  E)  $30^\circ$

36

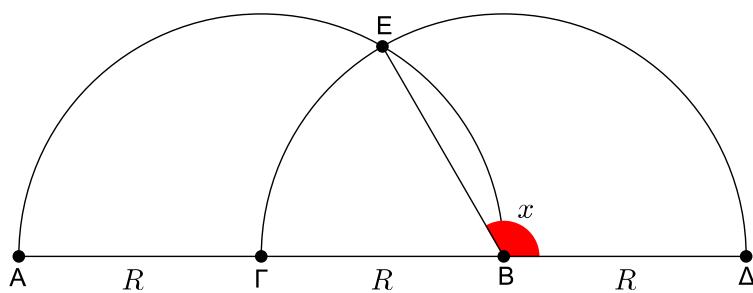

- A)  $100^\circ$  B)  $120^\circ$  Γ)  $135^\circ$  Δ)  $145^\circ$  E)  $150^\circ$

37

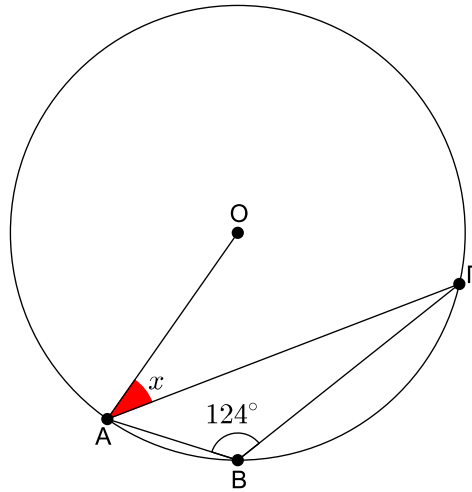

- A)  $24^\circ$  B)  $27^\circ$  Γ)  $32^\circ$  Δ)  $34^\circ$  E)  $37^\circ$

38

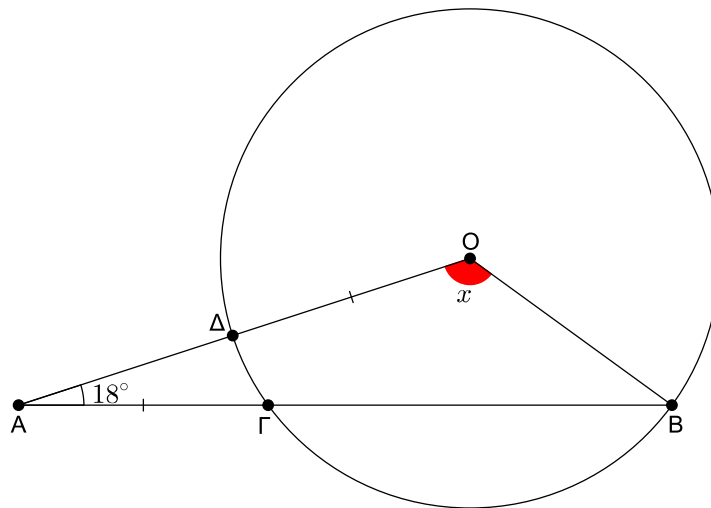

- A)  $132^\circ$  B)  $126^\circ$  Γ)  $120^\circ$  Δ)  $118^\circ$  E)  $108^\circ$

39

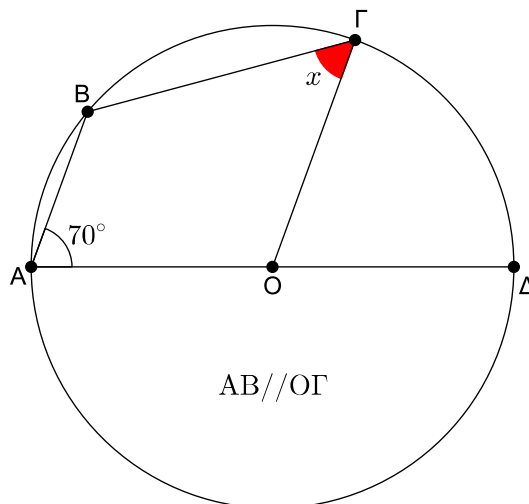

- A)  $60^\circ$  B)  $55^\circ$  Γ)  $50^\circ$  Δ)  $45^\circ$  E)  $40^\circ$

40

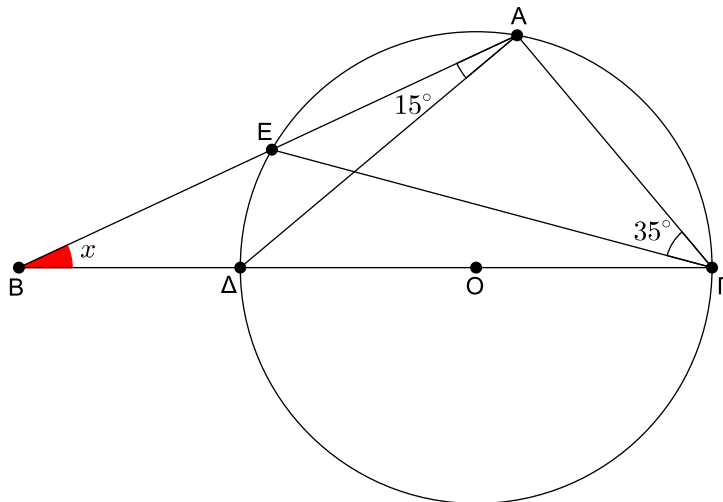

- A)  $15^\circ$  B)  $20^\circ$  Γ)  $25^\circ$  Δ)  $30^\circ$  E)  $35^\circ$

41

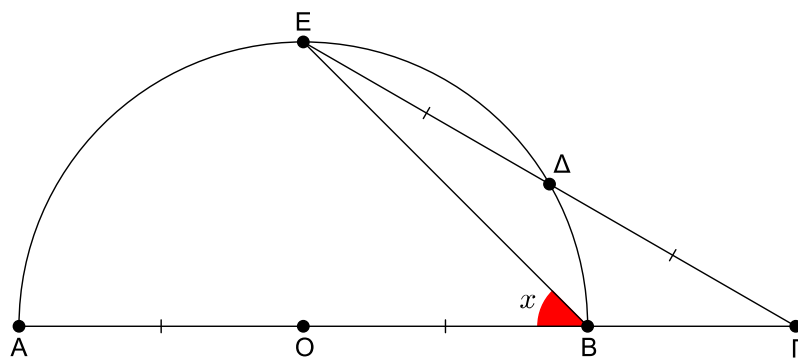

- A)  $45^\circ$  B)  $40^\circ$  Γ)  $35^\circ$  Δ)  $30^\circ$  E)  $25^\circ$

42

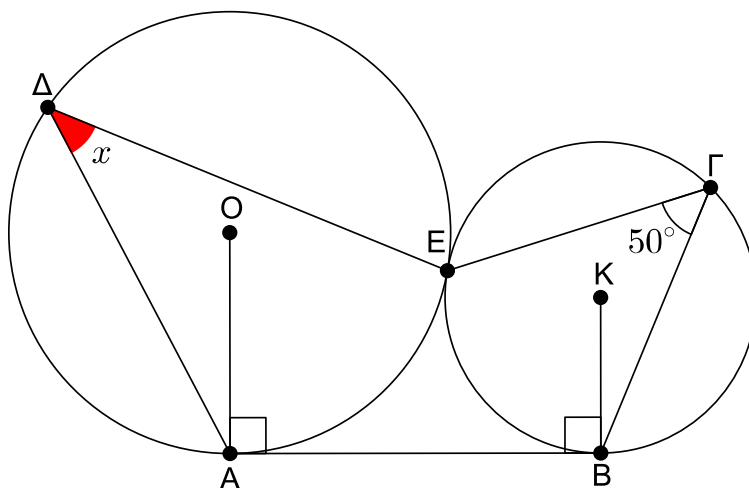

- A)  $40^\circ$  B)  $45^\circ$  Γ)  $50^\circ$  Δ)  $55^\circ$  E)  $60^\circ$



43

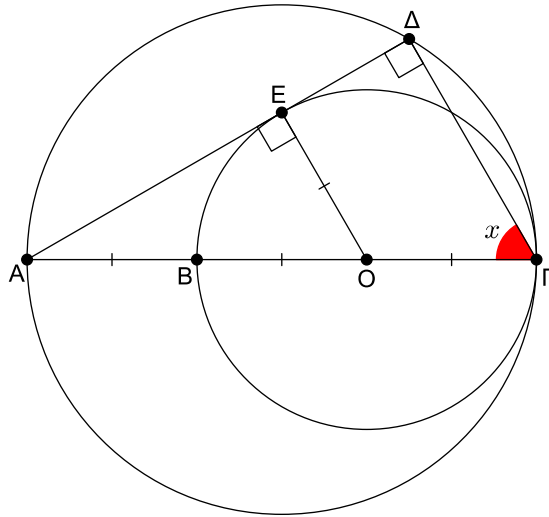

- A)  $30^\circ$  B)  $45^\circ$  Γ)  $50^\circ$  Δ)  $60^\circ$  E)  $75^\circ$

44

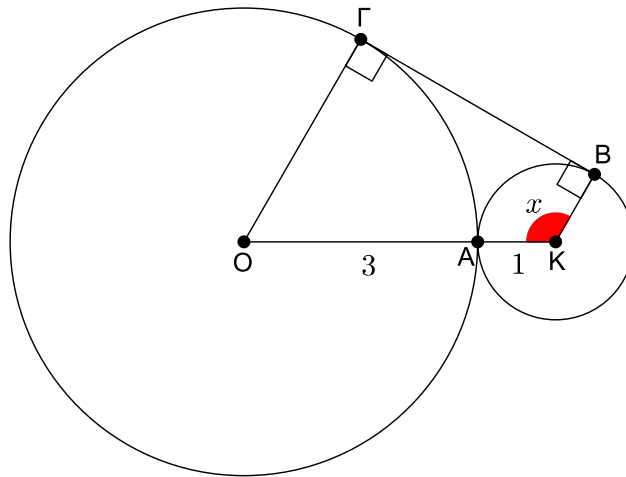

- A)  $90^\circ$  B)  $110^\circ$  Γ)  $120^\circ$  Δ)  $135^\circ$  E)  $150^\circ$

45

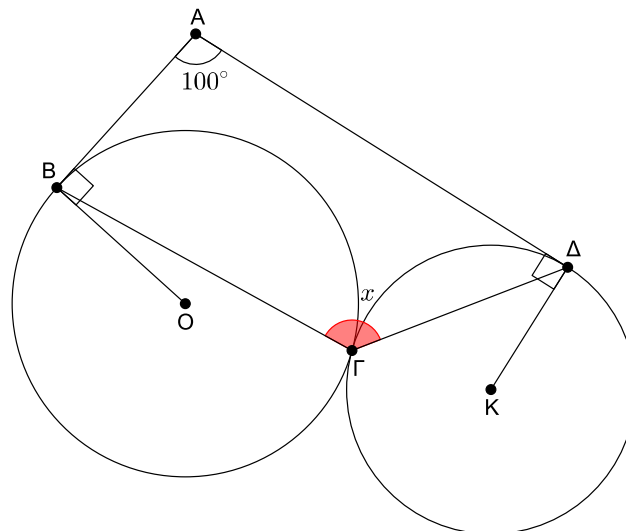

- A)  $150^\circ$  B)  $130^\circ$  Γ)  $120^\circ$  Δ)  $115^\circ$  E)  $110^\circ$

46

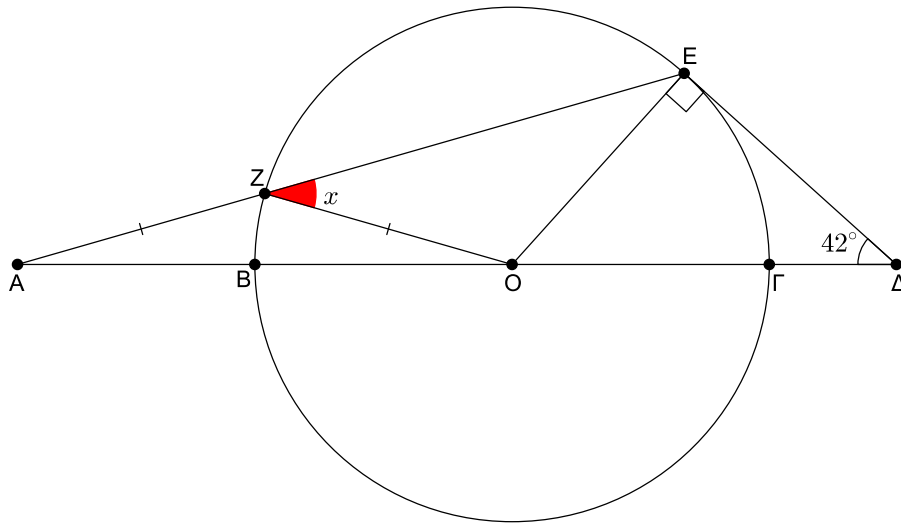

- A)  $40^\circ$  B)  $36^\circ$  Γ)  $34^\circ$  Δ)  $32^\circ$  E)  $30^\circ$

47

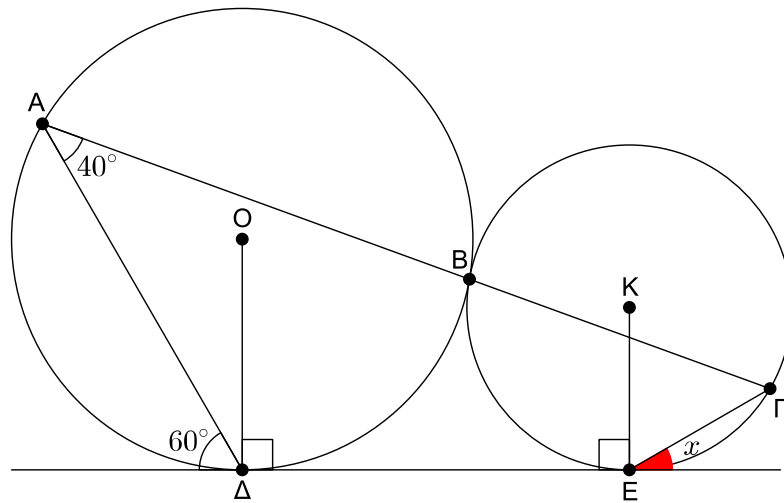

- A)  $20^\circ$  B)  $25^\circ$  Γ)  $30^\circ$  Δ)  $35^\circ$  E)  $40^\circ$

48

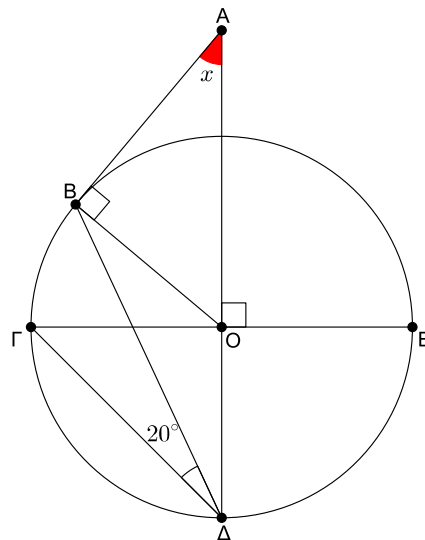

- A)  $50^\circ$  B)  $45^\circ$  Γ)  $40^\circ$  Δ)  $30^\circ$  E)  $35^\circ$

49

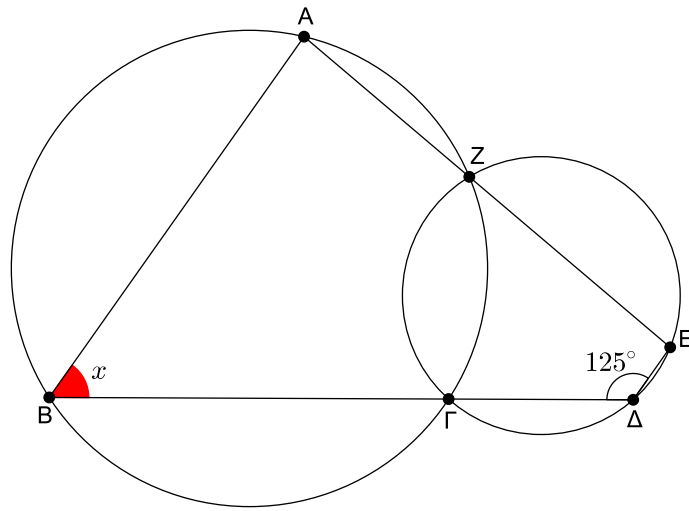

- A) 45° B) 50° Γ) 55° Δ) 60° E) 65°

50

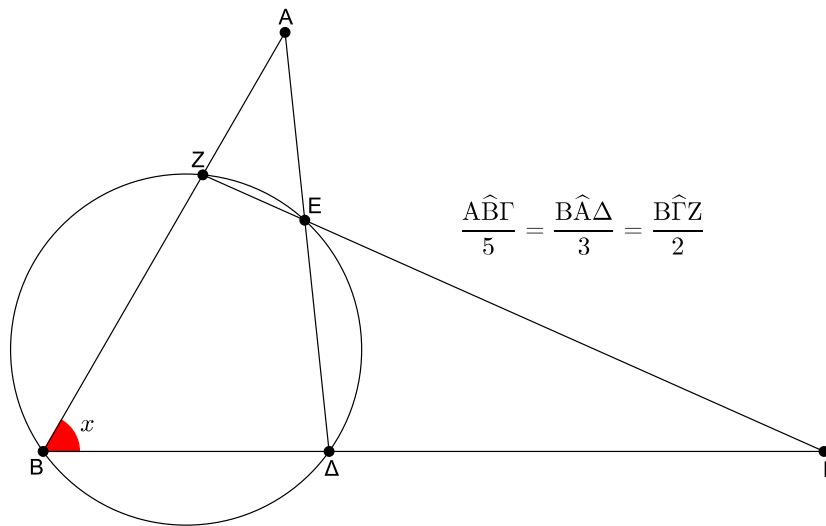

- A) 48° B) 60° Γ) 72° Δ) 84° E) 96°

51

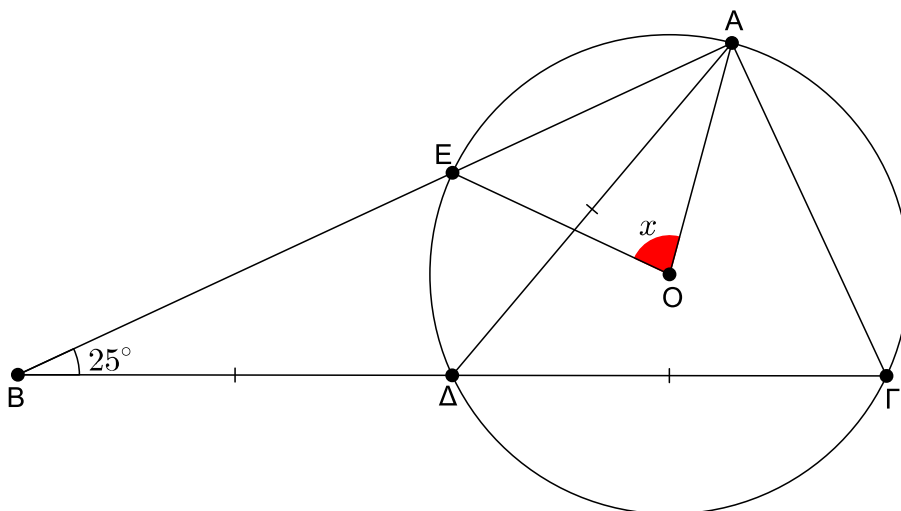

- A) 50° B) 60° Γ) 70° Δ) 80° E) 90°

52

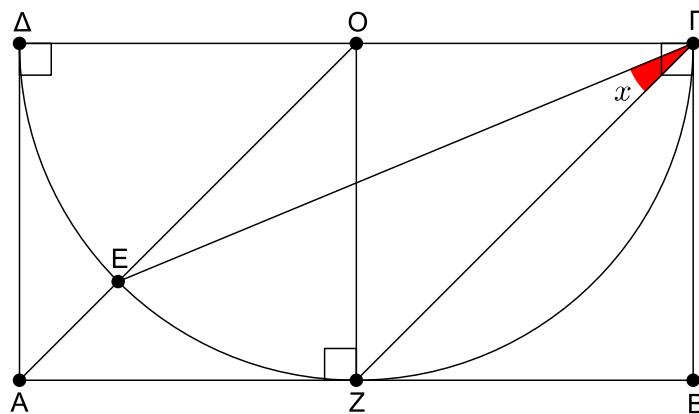

- A)  $10^\circ$  B)  $15^\circ$  Γ)  $22,5^\circ$  Δ)  $30^\circ$  E)  $37,5^\circ$

53

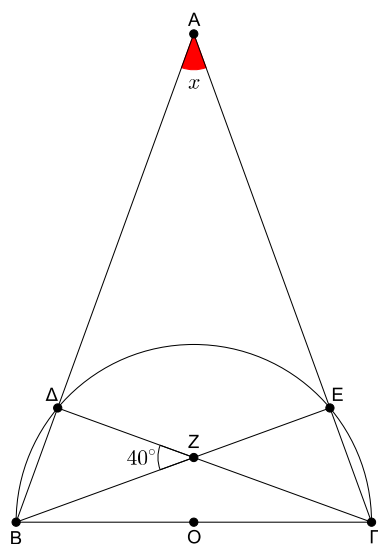

- A)  $20^\circ$  B)  $30^\circ$  Γ)  $40^\circ$  Δ)  $45^\circ$  E)  $50^\circ$

54

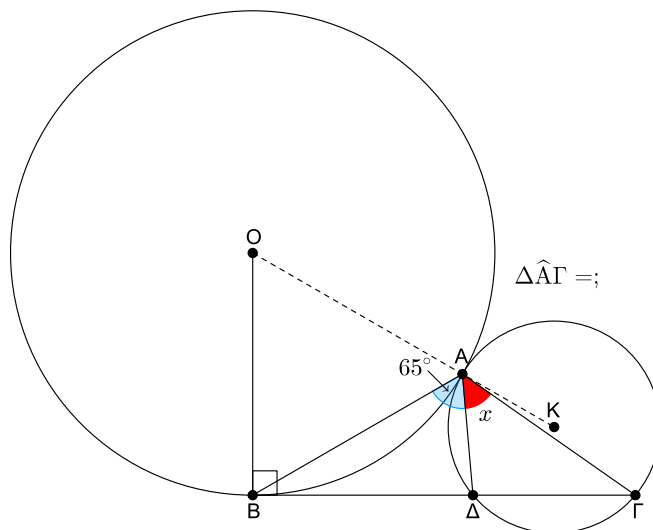

- A)  $45^\circ$  B)  $50^\circ$  Γ)  $55^\circ$  Δ)  $60^\circ$  E)  $65^\circ$

55

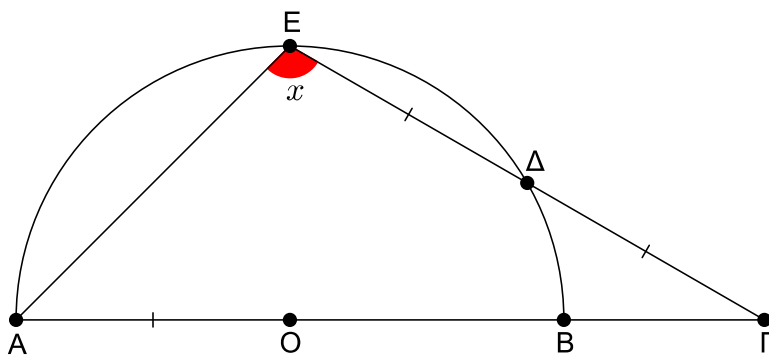

- A)  $105^\circ$  B)  $110^\circ$  Γ)  $115^\circ$  Δ)  $120^\circ$  E)  $130^\circ$

56

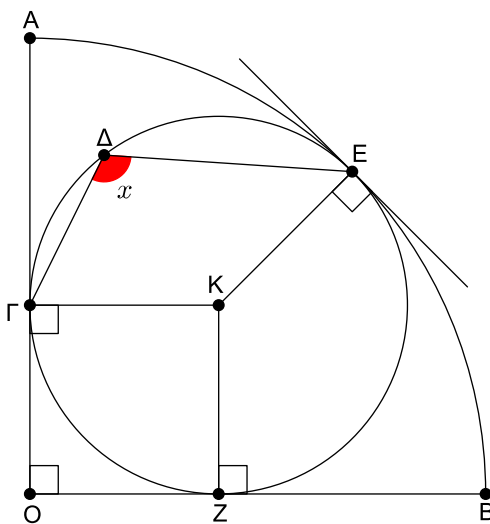

- A)  $135^\circ$  B)  $120^\circ$  Γ)  $112,5^\circ$  Δ)  $110^\circ$  E)  $109^\circ$

57

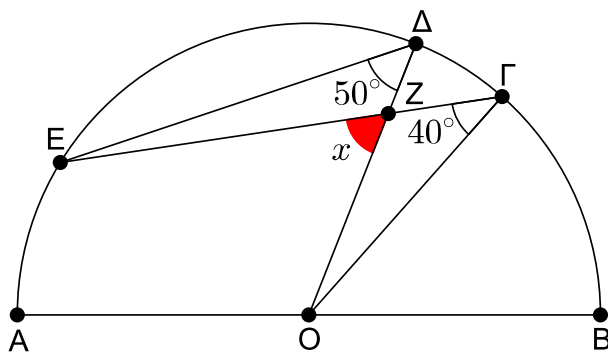

- A)  $65^\circ$  B)  $60^\circ$  Γ)  $55^\circ$  Δ)  $50^\circ$  E)  $45^\circ$

58

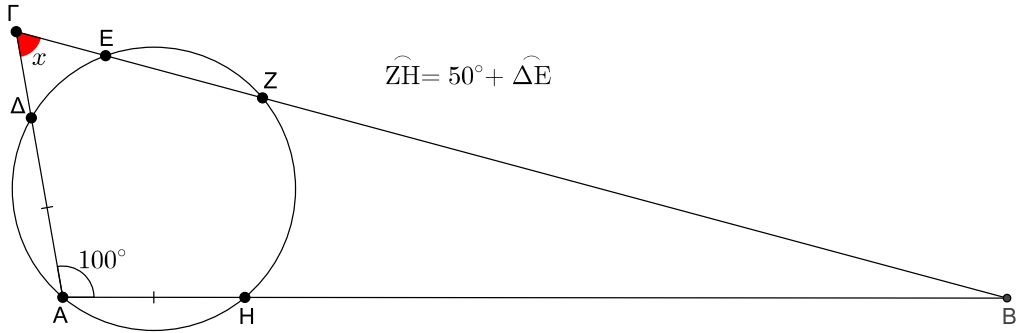

- A)  $80^\circ$  B)  $75^\circ$  Γ)  $70^\circ$  Δ)  $65^\circ$  E)  $60^\circ$

59

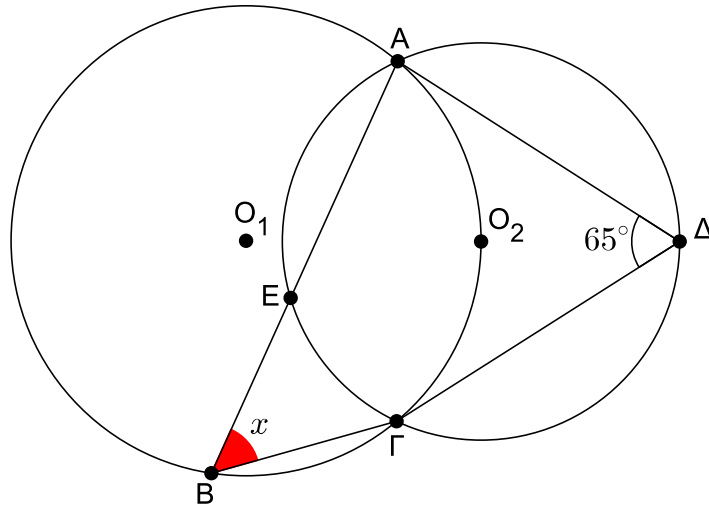

- A)  $50^\circ$  B)  $55^\circ$  Γ)  $60^\circ$  Δ)  $65^\circ$  E)  $70^\circ$

60

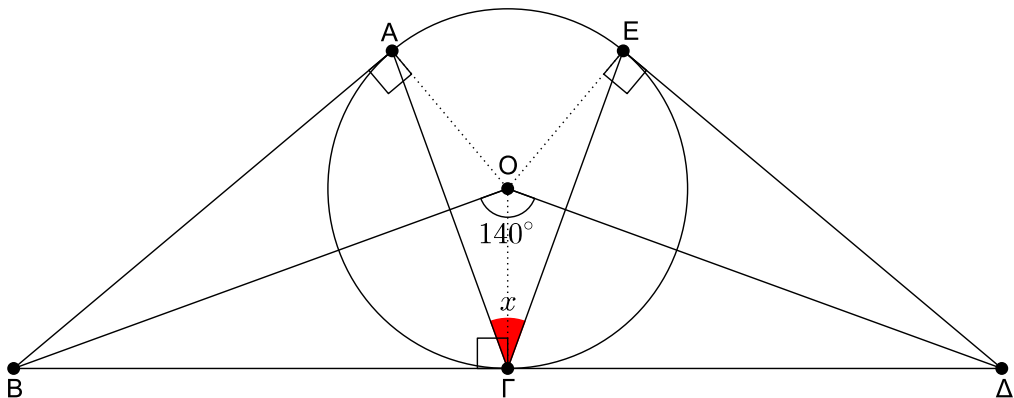

- A)  $30^\circ$  B)  $35^\circ$  Γ)  $40^\circ$  Δ)  $50^\circ$  E)  $70^\circ$

# ΑΠΑΝΤΗΣΕΙΣ

|      |      |
|------|------|
| 1-Γ  | 31-B |
| 2-Δ  | 32-Δ |
| 3-Γ  | 33-Γ |
| 4-E  | 34-E |
| 5-Γ  | 35-Δ |
| 6-B  | 36-B |
| 7-Γ  | 37-Δ |
| 8-Γ  | 38-B |
| 9-Δ  | 39-B |
| 10-A | 40-Γ |
| 11-E | 41-A |
| 12-Γ | 42-A |
| 13-Δ | 43-Δ |
| 14-Δ | 44-Γ |
| 15-E | 45-B |
| 16-Γ | 46-Δ |
| 17-B | 47-Γ |
| 18-Δ | 48-Γ |
| 19-Δ | 49-Γ |
| 20-Γ | 50-B |
| 21-A | 51-Δ |
| 22-Γ | 52-Γ |
| 23-A | 53-Γ |
| 24-A | 54-B |
| 25-B | 55-A |
| 26-E | 56-Γ |
| 27-Δ | 57-B |
| 28-A | 58-Δ |
| 29-Γ | 59-A |
| 30-B | 60-Γ |